

INTRODUCTION TO MACHINE VISION

A guide to automating process & quality improvements



COGNEX

TABLE OF CONTENTS

What is machine vision?	3	Lenses.....	15
Benefits of machine vision	5	Image sensor	15
Machine vision applications	6	Vision processing	16
Guidance.....	7	Communications	16
Identification	8	Different types of machine vision systems?	17
Gauging.....	9	1D Vision Systems	17
Inspection.....	10	2D Systems.....	18
Components of a machine vision system	11	Area scan vs. line scan.....	19
Lighting.....	13	3D Systems.....	20
Back lighting	13	Machine vision platforms	21
Axial diffuse lighting.....	13	PC-based machine vision	21
Structured light.....	13	Vision controllers.....	21
Directional lighting	14	Standalone vision systems.....	22
Dark-field illumination	14	Vision sensors and image-based barcode readers	22
Bright-field illumination.....	14	Conclusion	23
Diffused dome lighting	14		
Strobe lighting.....	14		

WHAT IS MACHINE VISION

According to the Automated Imaging Association (AIA), machine vision encompasses all industrial and non-industrial applications in which a combination of hardware and software provide operational guidance to devices in the execution of their functions based on the capture and processing of images. Though industrial computer vision uses many of the same algorithms and approaches as academic/educational and governmental/military applications of computer vision, constraints are different.

Industrial vision systems demand greater robustness, reliability, and stability compared with an academic/educational vision system and typically cost much less than those used in governmental/military applications. Therefore, industrial machine vision implies low cost, acceptable accuracy, high robustness, high reliability, and high mechanical, and temperature stability.

Machine vision systems rely on digital sensors protected inside industrial cameras with specialized optics to acquire images, so that computer hardware and software can process, analyze, and measure various characteristics for decision making.

As an example, consider a fill-level inspection system at a brewery (Figure 1). Each bottle of beer passes through an inspection sensor, which triggers a vision system to flash a strobe light and take a picture of the bottle. After acquiring the image and storing it in memory, vision software processes or analyzes it and issues a pass-fail response based on the fill level of the bottle. If the system detects an improperly filled bottle—a fail—it signals a diverter to reject the bottle. An operator can view rejected bottles and ongoing process statistics on a display.

Machine vision systems can also perform objective measurements, such as determining a spark plug gap or providing location information that guides a robot to align parts in a manufacturing process. Figure 2 shows examples of how machine vision systems can be used to pass or fail oil filters (right) and measure the width of a center tab on a bracket (left).

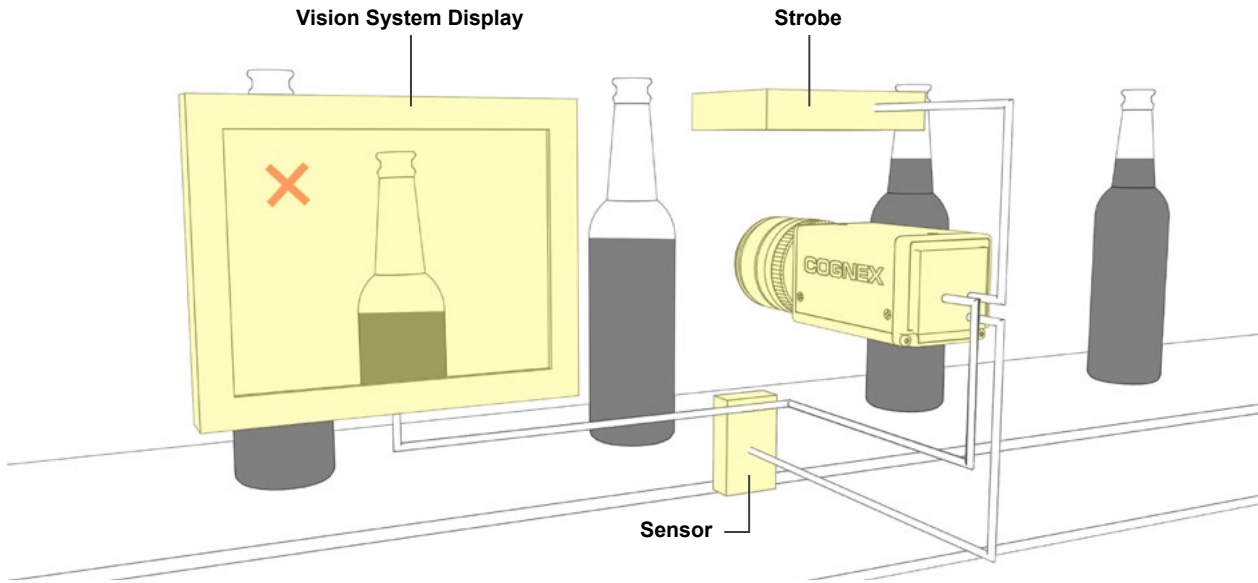

Figure 1. Bottle fill-level inspection example

The fill-level inspection system in this example permits only two possible responses, which characterizes it as a binary system:

1. Pass if the product is good
2. Fail if the product is bad.

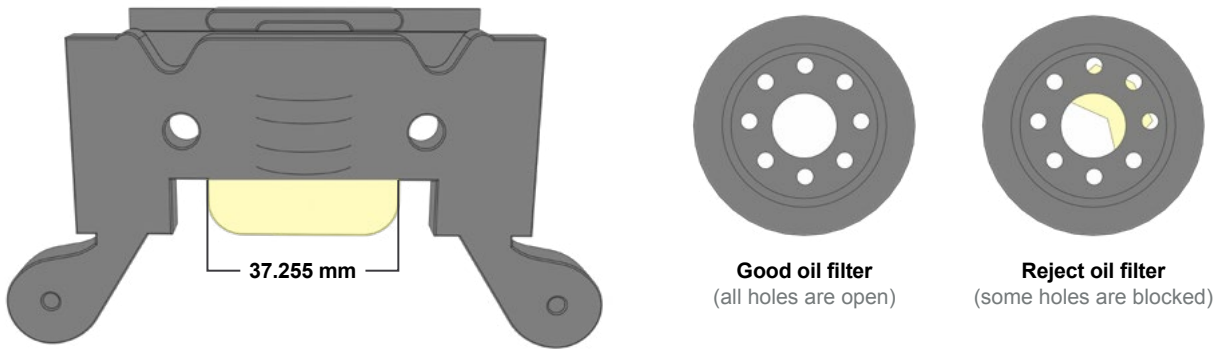

Figure 2.

Machine vision systems can process real-time measurements and inspections on the production line, such as a machined bracket (left) or oil filters (right).

BENEFITS OF MACHINE VISION

Where human vision is best for qualitative interpretation of a complex, unstructured scene, machine vision excels at quantitative measurement of a structured scene because of its speed, accuracy, and repeatability. For example, on a production line, a machine vision system can inspect hundreds, or even thousands, of parts per minute. A machine vision system built around the right camera resolution and optics can easily inspect object details too small to be seen by the human eye.

In removing physical contact between a test system and the parts being tested, machine vision prevents part damage and eliminates the maintenance time and costs associated with wear and tear on mechanical components. Machine vision brings additional safety and operational benefits by reducing human involvement in a manufacturing process. Moreover, it prevents human contamination of clean rooms and protects human workers from hazardous environments.

Machine vision helps meet strategic goals

Strategic Goal	Machine Vision Applications
Higher quality	Inspection, measurement, gauging, and assembly verification
Increased productivity	Repetitive tasks formerly done manually are now done by Machine Vision System
Production flexibility	Measurement and gauging / Robot guidance / Prior operation verification
Less machine downtime and reduced setup time	Changeovers programmed in advance
More complete information and tighter process control	Manual tasks can now provide computer data feedback
Lower capital equipment costs	Adding vision to a machine improves its performance, avoids obsolescence
Lower production costs	One vision system vs. many people / Detection of flaws early in the process
Scrap rate reduction	Inspection, measurement, and gauging
Inventory control	Optical Character Recognition and identification
Reduced floorspace	Vision system vs. operator

MACHINE VISION APPLICATIONS

Typically the first step in any machine vision application, whether the simplest assembly verification or a complex 3D robotic bin-picking, is for pattern matching technology to find the object or feature of interest within the camera's field of view. Locating the object of interest often determines success or failure. If the pattern matching software tools can not precisely locate the part within the image, then it can not guide, identify, inspect, count, or measure the part. While finding a part sounds simple, differences in its appearance in actual production environments can make that step extremely challenging (Figure 3). Although vision systems are trained to recognize parts based on patterns, even the most tightly controlled processes allow some variability in a part's appearance (Figure 4).

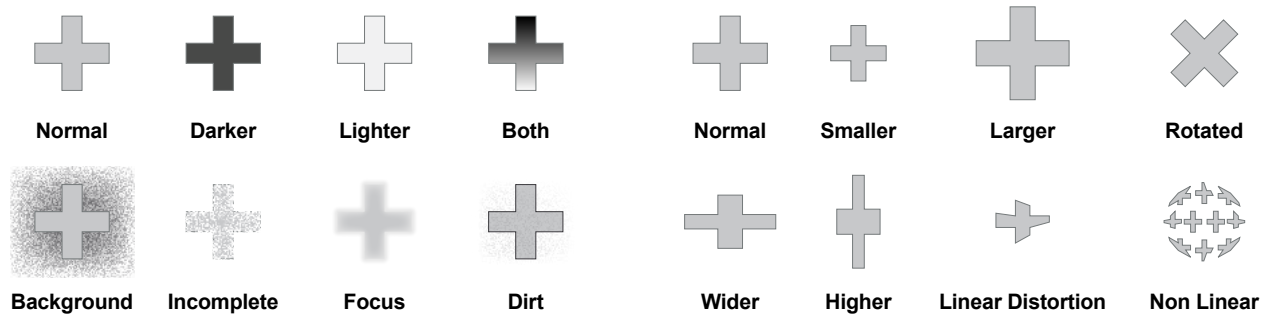

Figure 3.

Appearance changes due to lighting or occlusion can make part location difficult.

Figure 4.

Part presentation or pose distortion effects can make part location difficult.

To achieve accurate, reliable, and repeatable results, a vision system's part location tools must include enough intelligence to quickly and accurately compare training patterns to the actual objects (pattern matching) moving down a production line. Part location is the critical first step in the four major categories of machine vision applications. The categories are guidance, identification, gauging, and inspection, which can be remembered by the acronym (GIGI).

GUIDANCE

Guidance may be done for several reasons. First, machine vision systems can locate the position and orientation of a part, compare it to a specified tolerance, and ensure it's at the correct angle to verify proper assembly. Next, guidance can be used to report the location and orientation of a part in 2D or 3D space to a robot or machine controller, allowing the robot to locate the part or the machine to align the part. Machine vision guidance achieves far greater speed and accuracy than manual positioning in tasks such as arranging parts on or off pallets, packaging parts off a conveyor belt, finding and aligning parts for assembly with other components, placing parts on a work shelf, or removing parts from bins.

Guidance can also be used for alignment to other machine vision tools. This is a very powerful feature of machine vision because parts may be presented to the camera in unknown orientations during production. By locating the part and then aligning the other machine vision tools to it, machine vision enables automatic tool fixturing. This involves locating key features on a part to enable precise positioning of caliper, blob, edge, or other vision software tools so that they correctly interact with the part. This approach enables manufacturers to build multiple products on the same production line and reduces the need for expensive hard tooling to maintain part position during inspection.



Tomato sauce packets

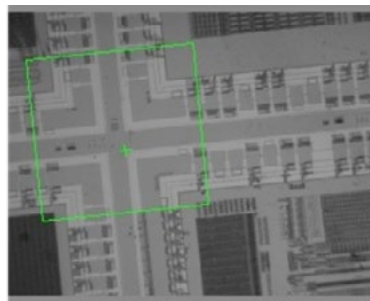

Printed circuit board

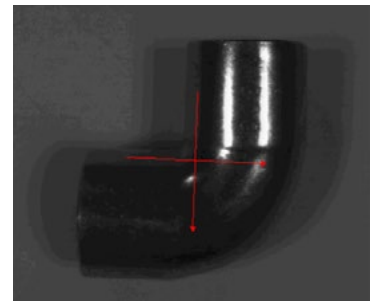

90 degree elbow

Figure 5a. Examples of images used in guidance.

Sometimes guidance requires geometric pattern matching. Pattern matching tools must tolerate large variations in contrast and lighting, as well as changes in scale, rotation, and other factors while finding the part reliably every time. This is because location information obtained by pattern matching enables the alignment of other machine vision software tools.

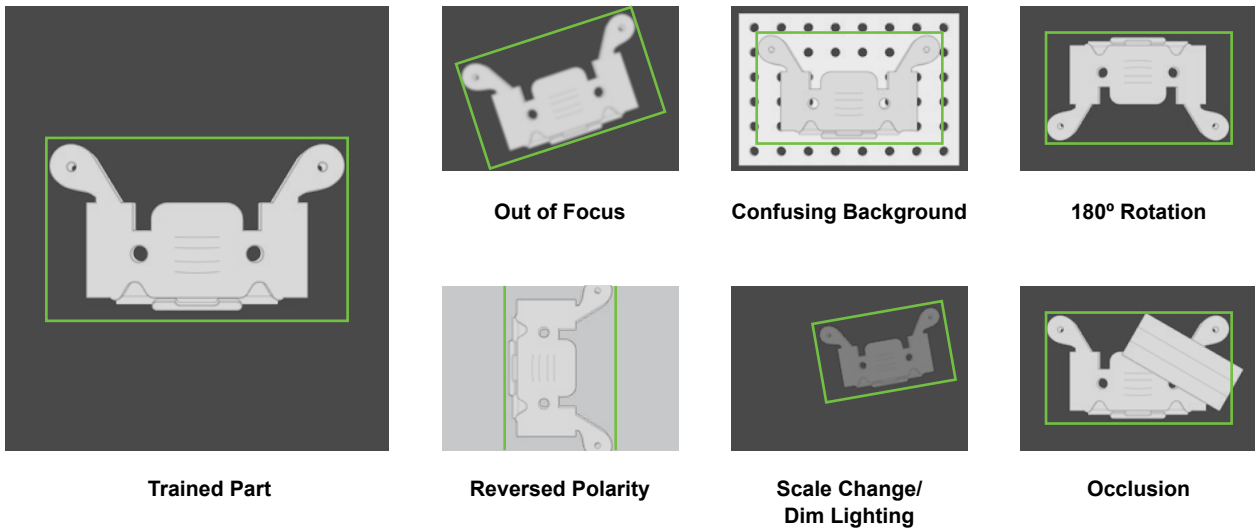

Figure 5b. Pattern matching can be challenging.

IDENTIFICATION

A machine vision system for part identification and recognition reads barcodes (1-D), data matrix codes (2-D), direct part marks (DPM), and characters printed on parts, labels, and packages. An optical character recognition (OCR) system reads alphanumeric characters without prior knowledge, whereas an optical character verification (OCV) system confirms the presence of a character string. Additionally, machine vision systems can identify parts by locating a unique pattern or identify items based on color, shape, or size.

DPM applications mark a code or character string directly on to the part. Manufacturers in all industries commonly use this technique for error-proofing, enabling efficient containment strategies, monitoring process control and quality-control metrics, and quantifying problematic areas in a plant such as bottlenecks. Traceability by direct part marking improves asset tracking and part authenticity verification. It also provides unit-level data to drive superior technical support and warranty repair service by documenting the genealogy of the parts in a sub-assembly that make up the finished product.



Figure 6. Identification techniques can range from simple barcode scanning to OCR.

Conventional barcodes have gained wide acceptance for retail checkout and inventory control. Traceability information, however, requires more data than can fit in a standard barcode. To increase the data capacity, companies developed 2-D codes, such as Data Matrix, which can store more information, including manufacturer, product identification, lot number, and even a unique serial number for virtually any finished good.

GAUGING

A machine vision system for gauging calculates the distances between two or more points or geometrical locations on an object and determines whether these measurements meet specifications. If not, the vision system sends a fail signal to the machine controller, triggering a reject mechanism that ejects the object from the line.

In practice, a fixed-mount camera captures images of parts as they pass the camera's field of view and the system uses software to calculate distances between various points in the image. Because many machine vision systems can measure object features to within 0.0254 millimeters, they address a number of applications traditionally handled by contact gauging.

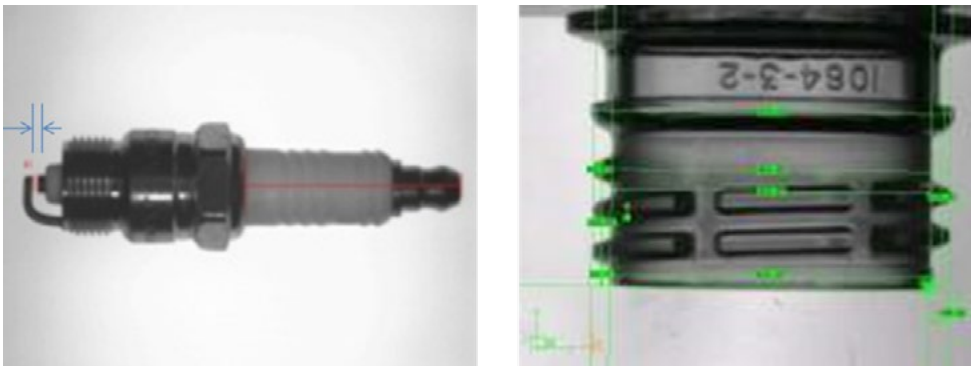

Figure 7. Gauging applications can measure part tolerances to within 0.0254 millimeters.

INSPECTION

A machine vision system for inspection detects defects, contaminants, functional flaws, and other irregularities in manufactured products. Examples include inspecting tablets of medicine for flaws, displays to verify icons or confirm pixel presence, or touch screens to measure the level of backlight contrast. Machine vision can also inspect products for completeness, such as ensuring a match between product and package in the food and pharmaceutical industries, and checking safety seals, caps, and rings on bottles.

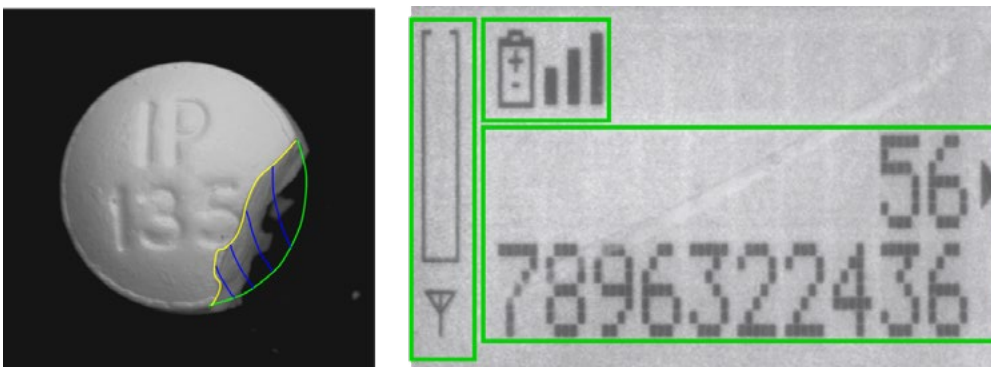

Figure 8. Machine vision systems can detect defects or functional flaws.

COMPONENTS OF MACHINE VISION

The major components of a machine vision system (Figure 9) include the lighting, lens, image sensor, vision processing, and communications. Lighting illuminates the part to be inspected allowing its features to stand out so they can be clearly seen by camera. The lens captures the image and presents it to the sensor in the form of light. The sensor in a machine vision camera converts this light into a digital image which is then sent to the processor for analysis.

Vision processing consists of algorithms that review the image and extract required information, run the necessary inspection, and make a decision. Finally, communication is typically accomplished by either discrete I/O signal or data sent over a serial connection to a device that is logging information or using it.

Most machine vision hardware components, such as lighting modules, sensors, and processors are available commercial off-the-shelf (COTS). Machine vision systems can be assembled from COTS, or purchased as an integrated system with all components in a single device.

The following pages list the various key components of a machine vision system including: lighting, lenses, vision sensor, image processing, vision processing, communications

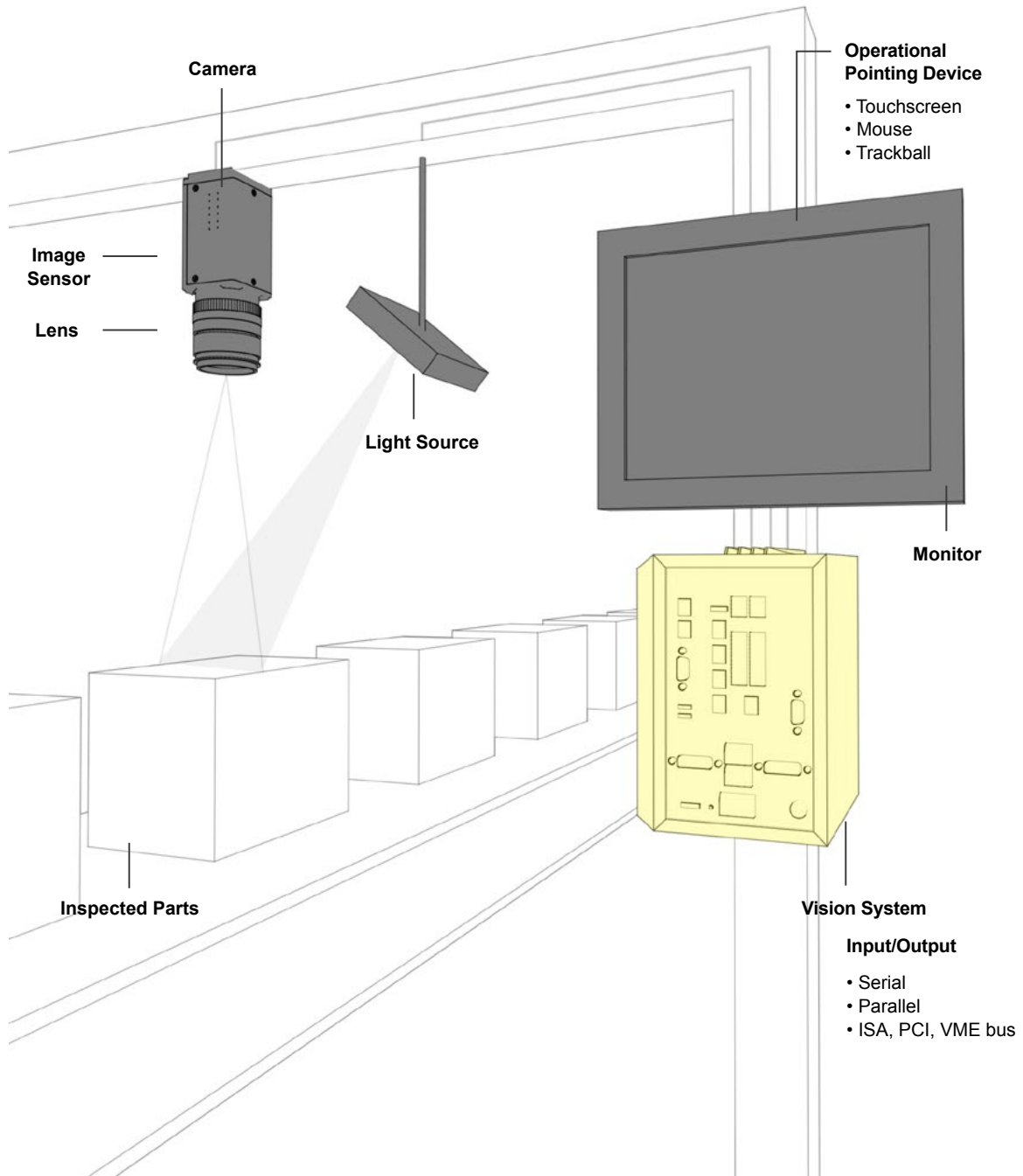
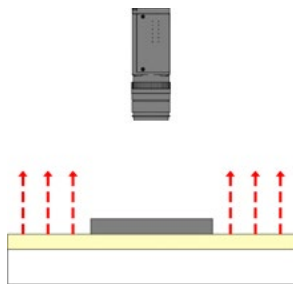

Figure 9. Main components of a machine vision system.

LIGHTING

Lighting is one key to successful machine vision results. Machine vision systems create images by analyzing the reflected light from an object, not by analyzing the object itself. A lighting technique involves a light source and its placement with respect to the part and the camera. A particular lighting technique can enhance an image such that it negates some features and enhances others, by silhouetting a part which obscures surface details to allow measurement of its edges, for example.



Back lighting

Back lighting enhances an object's outline for applications that need only external or edge measurements. Back lighting helps detect shapes and makes dimensional measurements more reliable.

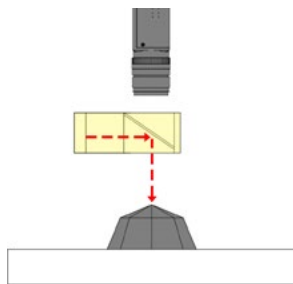

Axial diffuse lighting

Axial diffuse lighting couples light into the optical path from the side (coaxially). A semi-transparent mirror illuminated from the side, casts light downwards on the part. The part reflects the light back to the camera through the semi-transparent mirror resulting in a very evenly illuminated and homogeneous looking image.

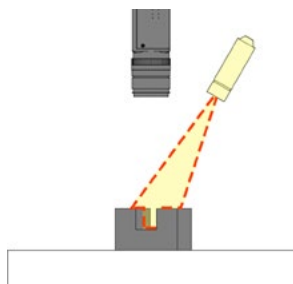

Structured light

Structured light is the projection of a light pattern (plane, grid, or more complex shape) at a known angle onto an object. It can be very useful for providing contrast-independent surface inspections, acquiring dimensional information and calculating volume.

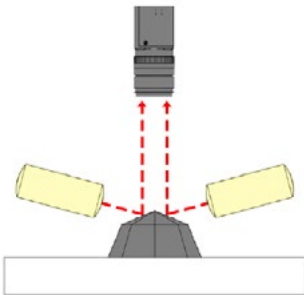

Dark-field illumination

Directional lighting more easily reveals surface defects and includes dark-field and bright-field illumination. Dark-field illumination generally preferred for low-contrast applications. In dark-field illumination, specular light is reflected away from the camera, and diffused light from surface texture and elevation changes are reflected into the camera.

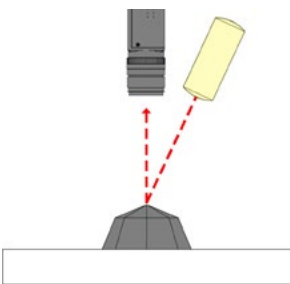

Bright-field illumination

Bright-field illumination is ideal for high-contrast applications. However, highly directional light sources such as high-pressure sodium and quartz halogen may produce sharp shadows and generally do not provide consistent illumination throughout the entire field of view. Consequently, hot-spots and specular reflections on shiny or reflective surfaces may require a more diffused light source to provide even illumination in the brightfield.

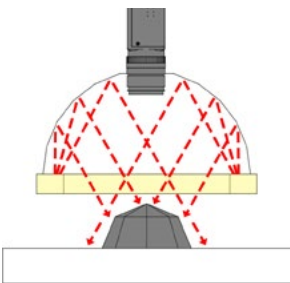

Diffused dome lighting

Diffused dome lighting gives the most uniform illumination of features of interest, and can mask irregularities that are not of interest and may be confusing to the scene.

Strobe lighting

Strobe lighting is used in high-speed applications to freeze moving objects for examination. Using a strobe light also helps to prevent blurring.

For more information on lighting techniques, please download the Cognex expert guide “How to Choose the Right Lighting for Machine Vision Applications” available at cognex.com/lightingexpertguide

LENSES

The lens captures the image and delivers it to the image sensor in the camera. Lens will vary in optical quality and price, the lens used determines the quality and resolution of the captured image. Most vision system cameras offer two main types of lenses: interchangeable lenses and fixed lenses. Interchangeable lenses are typically C-mounts or CS-mounts. The right combination of lens and extension will acquire the best possible image. A fixed lens as part of a standalone vision system typically uses autofocus, which could be either a mechanically adjusted lens or a liquid lens that can automatically focus on the part. Autofocus lenses usually have a fixed field of view at a given distance.

For more information on lenses, please download the Cognex expert guide "Using Optics to Optimize Your Machine Vision Application" available at cognex.com/lensexpertguide

IMAGE SENSOR

The camera's ability to capture a correctly-illuminated image of the inspected object depends not only on the lens, but also on the image sensor within the camera. Image sensors typically use a charge coupled device (CCD) or complementary metal oxide semiconductor (CMOS) technology to convert light (photons) to electrical signals (electrons). Essentially the job of the image sensor is to capture light and convert it to a digital image balancing noise, sensitivity and dynamic range. The image is a collection of pixels. Low light produces dark pixels, while bright light creates brighter pixels. It's important to ensure the camera has the right sensor resolution for the application. The higher the resolution, the more detail an image will have, and the more accurate measurements will be. Part size, inspection tolerances, and other parameters will dictate the required resolution.

For more information on sensor resolution, please download the Cognex expert guide "Using Optics to Optimize Your Machine Vision Application" available at cognex.com/lensexpertguide

VISION PROCESSING

Processing is the mechanism for extracting information from a digital image and may take place externally in a PC-based system, or internally in a standalone vision system. Processing is performed by software and consists of several steps. First, an image is acquired from the sensor. In some cases, pre-processing may be required to optimize the image and ensure that all the necessary features stand out. Next, the software locates the specific features, runs measurements, and compares these to the specification. Finally, a decision is made and the results are communicated.

While many physical components of a machine vision system (such as lighting) offer comparable specifications, the vision system algorithms set them apart and should top the list of key components to evaluate when comparing solutions. Depending on the specific system or application, vision software configures camera parameters, makes the pass-fail decision, communicates with the factory floor, and supports HMI development.

COMMUNICATIONS

Since vision systems often use a variety of off-the-shelf components, these items must coordinate and connect to other machine elements quickly and easily. Typically this is done by either discrete I/O signal or data sent over a serial connection to a device that is logging information or using it. Discrete I/O points may be connected to a programmable logic controller (PLC), which will use that information to control a work cell or an indicator such as a stack light or directly to a solenoid which might be used to trigger a reject mechanism.

Data communication by a serial connection can be in the form of a conventional RS-232 serial output, or Ethernet. Some systems employ a higher-level industrial protocol like Ethernet/IP, which may be connected to a device like a monitor or other operator interface to provide an operator interface specific to the application for convenient process monitoring and control.

For more information communications and I/O, please download the Cognex Tech Note “Get Control of Your Vision and ID Systems” available at cognex.com/getcontroltechnote

DIFFERENT TYPES OF MACHINE VISION SYSTEMS

Broadly speaking, there are 3 categories of machine vision systems: 1D, 2D and 3D.

1D VISION SYSTEMS

1D vision analyzes a digital signal one line at a time instead of looking at a whole picture at once, such as assessing the variance between the most recent group of ten acquired lines and an earlier group. This technique commonly detects and classifies defects on materials manufactured in a continuous process, such as paper, metals, plastics, and other non-woven sheet or roll goods, as shown in Figure 10.

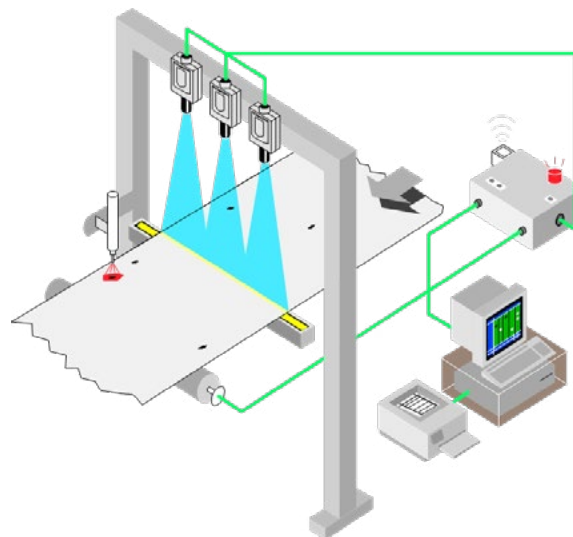

Figure 10. 1D vision systems scan one line at a time while the process moves. In the above example, a defect in the sheet is detected.

2D VISION SYSTEMS

Most common inspection cameras perform area scans that involve capturing 2D snapshots in various resolutions, as shown in Figure 11. Another type of 2D machine vision—line scan—builds a 2D image line by line, as shown in Figure 12.

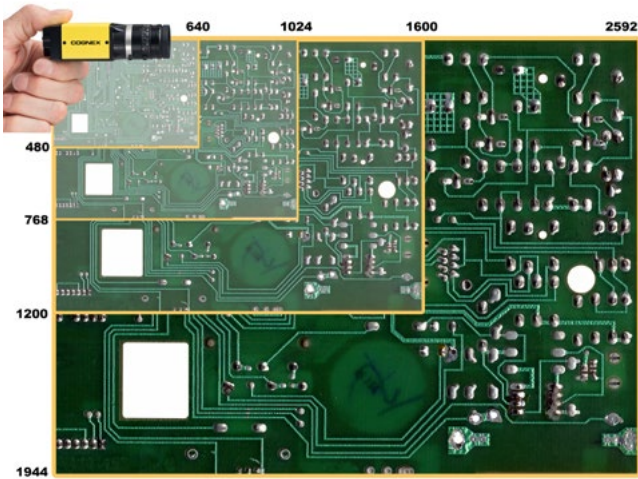

Figure 11.

2D vision systems can produce images with different resolutions.

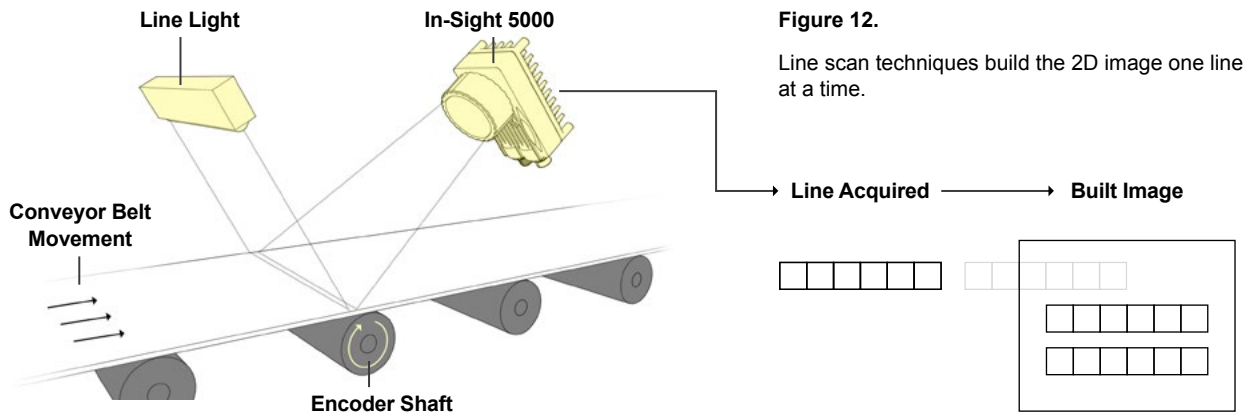

Figure 12.

Line scan techniques build the 2D image one line at a time.

AREA SCAN VS. LINE SCAN

In certain applications, line scan systems have specific advantages over area scan systems. For example, inspecting round or cylindrical parts may require multiple area scan cameras to cover the entire part surface. However, rotating the part in front of a single line scan camera captures the entire surface by unwrapping the image. Line scan systems fit more easily into tight spaces for instances when the camera must peek through rollers on a conveyor to view the bottom of a part. Line scan systems can also generally provide much higher resolution than traditional cameras. Since line scan systems require parts in motion to build the image, they are often well-suited for products in continuous motion.



a.



b.

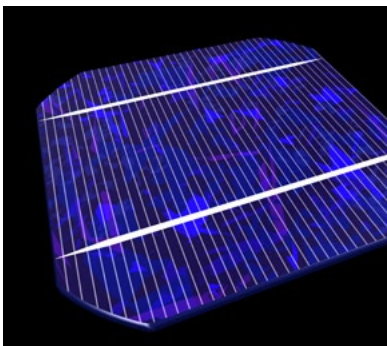

c.



d.

Figure 13. Line scan cameras can (a.) unwrap cylindrical objects for inspection, (b.) add vision to space-constrained environments, (c.) meet high-resolution inspection requirements, and (d.) inspect objects in continuous motion.

3D SYSTEMS

3D machine vision systems typically comprise multiple cameras or one or more laser displacement sensors. Multi-camera 3D vision in robotic guidance applications provides the robot with part orientation information. These systems involve multiple cameras mounted at different locations and “triangulation” on an objective position in 3-D space.

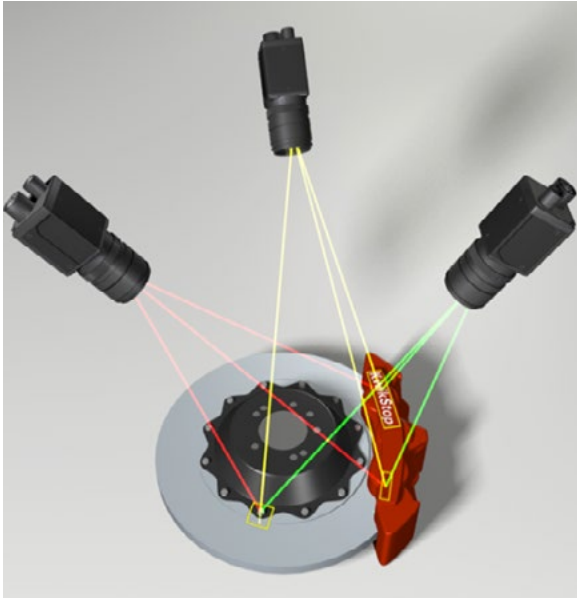

Figure 14.
3D vision systems typically employ multiple cameras.

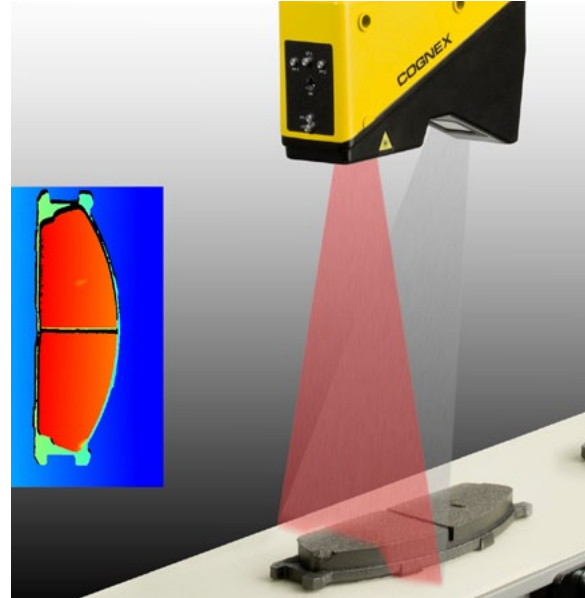

Figure 15.
3D inspection system using a single camera.

In contrast, 3D laser-displacement sensor applications typically include surface inspection and volume measurement, producing 3D results with as few as a single camera. A height map is generated from the displacement of the reflected lasers' location on an object. The object or camera must be moved to scan the entire product similar to line scanning. With a calibrated offset laser, displacement sensors can measure parameters such as surface height and planarity with accuracy within 20 μm . Figure 15 shows a 3D laser displacement sensor inspecting brake pad surfaces for defects.

MACHINE VISION PLATFORMS

Machine vision implementation comes on several physical platforms, including PC-based systems, vision controllers designed for 3D and multi-camera 2D applications, standalone vision systems, simple vision sensors, and image-based barcode readers. Choosing the right machine vision platform generally depends on the application's requirements, including development environment, capability, architecture, and cost.

PC-BASED MACHINE VISION

PC-based systems easily interface with direct-connect cameras or image acquisition boards and are well supported with configurable machine vision application software. In addition, PCs provide a wealth of custom code development options using familiar and well-supported languages such as Visual C/C++, Visual Basic, and Java, plus graphical programming environments. However, development tends to be long and complicated, so is usually limited to large installations and appeal mostly to advanced machine vision users and programmers.

VISION CONTROLLERS

Vision controllers offer all of the power and flexibility of PC-based system, but are better able to withstand the rigors of harsh factory environments. Vision controllers allow for easier configuration of 3D and multi-camera 2D applications, perhaps for one-off tasks where a reasonable amount of time and money is available for development. This allows for more sophisticated applications to be configured in a very cost-effective way.

STANDALONE VISION SYSTEMS

Standalone vision systems are cost effective and can be quickly and easily configured. These systems come complete with the camera sensor, processor, and communications. Some also integrate lighting and autofocus optics. In many cases these systems are compact and affordable enough to be installed throughout the factory. By using standalone vision systems at key process points, defects can be caught earlier in the manufacturing process and equipment problems can be identified more quickly. Most offer built-in Ethernet communications, which enables users to not only distribute vision throughout the process, but to link two or more systems together in a fully-manageable, scalable vision area network in which data is exchanged between systems and managed by a host. A network of vision systems can also be easily uplinked to plant and enterprise networks, allowing any workstation in the factory with TCP/IP capability to remotely view vision results, images, statistical data, and other information. These systems offer configurable environments that provide easy guided setup or more advanced programming and scripting. Some standalone vision systems provide both development environments allowing for easy set up with the added power, and flexibility of programming and scripting for greater control of system configuration and handling of vision-application data.

VISION SENSORS AND IMAGE-BASED BARCODE READERS

Vision sensors and image-based barcode readers generally require no programming, and provide user-friendly interfaces. Most are easily integrated with any machine to provide single-point inspections with dedicated processing, and offer built-in Ethernet communications for factory-wide networkability.

CONCLUSION

Machine vision is the automatic extraction of information from digital images for process or quality control. Most manufacturers use automated machine vision instead of human inspectors because it is better suited to repetitive inspection tasks. It is faster, more objective, and works continuously. Machine vision can inspect hundreds or even thousands of parts per minute, and provides more consistent and reliable inspection results 24 hours a day, 7 days a week.

Measurement, counting, location, and decoding are some of the most common applications for machine vision in manufacturing today. By reducing defects, increasing yield, facilitating compliance with regulations and tracking parts with machine vision, manufacturers can save money and increase profitability.

For more information on how machine vision can help your organization reduce waste, minimize downtime, and improve processes [contact Cognex](#)

Or visit these online resources for more information:

- [Cognex Machine Vision](#)
- [Cognex Vision Systems](#)
- [Cognex Vision Sensors](#)
- [Cognex 3D Vision](#)
- [Cognex Industrial Barcode Readers](#)

VISION FOR EVERY INDUSTRY

Cognex vision systems perform 100% inspection, ensure brand quality and improve your production processes. With over one million systems installed worldwide, Cognex machine vision systems are accepted in nearly every industry and used by most major manufacturers.

Automotive



The manufacturing processes for building virtually every system and component within an automobile can benefit from the use of machine vision.

Mobile Devices



Machine-vision-enabled robots provide scalable, final assembly of mobile phones, tablets, and wearable devices. Cognex vision technology enables high precision touchscreen display manufacturing and 3D quality inspection.

Medical Devices



Quality inspection is critical to success. Liability for defective products, inconsistent quality, rapidly changing costs and pending regulations, all challenge medical device manufacturers.

Consumer Products



Improve production and packaging operations with high-speed image acquisition, advanced color tools, and 3D inspection systems.

Pharmaceutical



The need to comply with patient safety and traceability requirements is imperative, and machine vision helps meet compliance goals.

Food & Beverage



Food and beverage applications require vision that can perform precisely, accurately and quickly to keep up with the fast-paced production lines.

Semiconductor



Cognex vision provides the precise, sub-pixel alignment and identification essential to every step of the semiconductor manufacturing process, despite increasingly fine geometries and process effect challenges.

Electronics



Machine vision provides the high-speed alignment and traceability for electronics assembly, even on the newest miniaturized components and flexible circuits.

COGNEX

Companies around the world rely on Cognex vision and barcode reading solutions to optimize quality, drive down costs and control traceability.

Corporate Headquarters One Vision Drive Natick, MA 01760 USA

Regional Sales Offices

Americas

North America +1 844-999-2469
Brazil +55 (11) 2626 7301
Mexico +01 800 733 4116

Europe

Austria +49 721 958 8052
Belgium +32 289 370 75
France +33 1 7654 9318
Germany +49 721 958 8052

Hungary +36 800 80291
Ireland +44 121 29 65 163
Italy +39 02 3057 8196
Netherlands +31 207 941 398
Poland +48 717 121 086
Spain +34 93 299 28 14
Sweden +46 21 14 55 88
Switzerland +41 445 788 877
Turkey +90 216 900 1696
United Kingdom +44 121 29 65 163

Asia

China +86 21 6208 1133
India +9120 4014 7840
Japan +81 3 5977 5400
Korea +82 2 539 9980
Malaysia +6019 916 5532
Singapore +65 632 55 700
Taiwan +886 3 578 0060
Thailand +66 88 7978924
Vietnam +84 2444 583358

www.cognex.com

© Copyright 2018, Cognex Corporation. All information in this document is subject to change without notice. Cognex, PatMax, 1DMax, In-Sight, EasyBuilder, DataMan, VisionView, SensorView, Checker and VisionPro are registered trademarks and OCRMax, the Cognex logo, Cognex Connect, Cognex Designer and PatMax RedLine are trademarks of Cognex Corporation. All other trademarks are the property of their respective owners. Printed in the USA. Lit. No. IMVWP-2018-EN